

UK

USER MANUAL

# FLEXSTEP V2

UK VS. 09.02



liftup

lifting people

# Contents

1. Foreword.....	3
2. Declarations of Conformity.....	4
2.1 EU Declaration of Conformity .....	4
2.2 UK Declaration of Conformity.....	5
3. Factory Acceptance Test (FAT).....	6
4. Terms of use.....	7
5. Technical specifications.....	8
6. Safety instructions.....	11
6.1 Installation, handling and repair .....	11
6.2 Unintended movements of the lift.....	11
6.3 Operating conditions .....	11
6.4 Avoid personal injury .....	11
6.5 Overloading the lift.....	12
6.6 Personal safety .....	12
6.7 Anti-crushing safety feature.....	12
6.7.1 Infrared anti-crush safety device.....	13
6.8 Safety barriers.....	14
6.8.1 Ramp as safety barrier.....	14
6.8.2 Automatic onboard barrier (optional equipment) .....	14
6.8.3 Vertical barrier (optional equipment) .....	15
6.8.4 Automatic door (optional equipment).....	16
6.9 Lifts installed with free access (only certain countries).....	16
6.10 Breakdown/malfunction.....	16
6.10.1 Opening of vertical barrier in emergency .....	16
6.10.2 Unlocking the door in an emergency .....	17
6.10.3 Unlocking the automatic onboard barrier in an emergency .....	18
6.10.4 Emergency lighting/power failure .....	18
6.10.5 Electrical or mechanical faults/defects.....	18
6.10.6 Emergency evacuation in the event of a malfunction .....	18
7. Function description.....	19
8. Assembly .....	19
9. Start-up.....	19



10. Instructions for the use .....	19
10.1 Everyday use.....	20
10.2 Operation of the FlexStep from the UPPER level.....	21
10.3 Operation of the FlexStep from the LOWER level .....	22
10.4 Operation of FlexStep on the platform.....	22
10.5 Return to staircase and auto return.....	23
10.6 Emergency stop .....	23
10.7 ON/OFF switch for the battery charger .....	24
10.8 Acoustic alarms .....	25
10.9 Alarm and emergency call .....	26
11. Operation.....	27
11.1 Battery back-up .....	27
11.2 Calibration after emergency stop/power failure .....	27
12. Maintenance.....	28
12.1 Replacement of battery in call stations/remote control .....	28
13. Pairing transmitter and receiver .....	30
13.1 Wireless call station/call station column 2.4 GHz .....	30
13.2 Remote control 2.4 GHz .....	32
14. Installation and handover.....	34
15. Inspection, checks and service inspections .....	35
15.1 Statutory inspection and checks.....	35
15.2 Regular service inspections.....	35
15.3 Service report to be used for service inspections .....	36
15.4 Service logbook .....	37
16. Online service log (only certain countries).....	38
17. Spare parts and accessories.....	39
18. Disassembly .....	40
19. Disposal .....	40
19.1 Material specification for FlexStep.....	40
20. Warranty .....	41

October 2024



# 1. Foreword

Congratulations on the purchase of your new FlexStep V2 wheelchair lift, an aesthetic and innovative 2-in-1 solution that is both an ordinary staircase and a sophisticated wheelchair lift for use in the home, at the office and in other locations.

This is an original user manual for your new FlexStep V2. In the following text, we use the name FlexStep for the FlexStep V2 unless specifically stated otherwise.



## **IMPORTANT!**

It is important to read the entire user manual before using the lift

Set-up and installation **MUST** be carried out by a service technician trained by Liftup in order to ensure correct assembly. Incorrect assembly could cause a risk of inadvertent elements of danger.

Service and maintenance must be performed in accordance with Liftup's guidelines and applicable legislation with regard to service intervals.

The FlexStep is an elegant combination of a normal staircase and a wheelchair lift that provides wheelchair users and persons with impaired mobility with access between two levels.

The lift is operated easily by means of operating panels mounted on the wall, on a free-standing call station column on the lift or by means of a remote control (optional equipment).

**In this user manual, the “FlexStep V2” is referred to as the “lift” when functioning as a wheelchair lift.**

Where an “authorised service technician” is referred to below, this refers to a service technician who has completed a product and service course at Liftup.



## 2. Declarations of Conformity

### 2.1 EU Declaration of Conformity

**Manufacturer:** Liftup A/S  
**Address:** Hagensvej 21, DK-9530 Støvring, Denmark  
**Telephone:** +45 9686 3020



hereby declares that:

**Equipment:** **FlexStep V2**  
Combination stairlift for wheelchair users and persons with impaired mobility

**Year:** **2019**

The equipment complies with important requirements in the CE Marking Directives:

The Machinery Directive:	2006/42/EC
The Electromagnetic Compatibility Directive (EMC):	2014/30/EU
Restriction on Hazardous Substances (RoHS):	2011/65/EU
The Radio Equipment Directive (RED):	2014/53/EU

The equipment complies with requirements based on the following standards:

ISO 9386-1:2000	Power-operated lifting platforms for persons with impaired mobility
DS/ EN 60204-1	Electrical Equipment on Machines
DS/EN 13849-1 and -2	Safety related parts of control systems

_____ CEO <b>Position</b>	_____ Søren Elisiussen <b>Name</b>
_____ Liftup A/S, Hagensvej 21, DK-9530 Støvring, Denmark <b>Location</b>	
_____ 10 February 2020 <b>Date</b>	_____  <b>Signature</b>



## 2.2 UK Declaration of Conformity

### UK Declaration of Conformity

UK Declaration, FlexStep V2 – Version 02.01

<p>Manufacturer: Liftup A/S          Address: Hagensvej 21, DK-9530 Støvring, Denmark          Phone: +45 9686 3020</p>	<div style="text-align: right; font-size: 2em; font-weight: bold; margin-bottom: 20px;">UK CA</div> <div style="display: flex; justify-content: space-between; align-items: center;"> <div style="width: 60%;"> <p>UK authorized representative: UKCA Experts Ltd.              Full business address: Dept 302, 43 Owston Road, Carcroft, Doncaster, DN6 8DA, the United Kingdom and is part of AR Experts B.V. located at Amerlandseweg 7, 3621 ZC Breukelen, the Netherlands</p> </div> <div style="width: 35%; text-align: center;">  </div> </div>
<p>Machine description: Combination stairlift for wheelchair users and persons with impaired mobility          Year: 2024</p>	

The serial number is present on the individual machine in combination with the UKCA-mark, indicating that the machine is covered by this declaration of conformity.

We declare that this product complies with CE-marking legislation hence also the legislation:

- Supply of Machinery (Safety) Regulations 2008
- Electromagnetic Compatibility Regulations 2016
- The Restriction of the Use of Certain Hazardous Substances in Electrical and Electronic Equipment Regulations 2012
- Radio Equipment Regulations 2017

The following British Standards have been used:

BS EN ISO 9001: 2015	Quality Management Systems
BS EN ISO 60204-1:2018	Safety of machinery - Electrical equipment of machines - Part 1: General requirements
BS EN ISO 13849-1:2015	Safety of machinery — Safety-related parts of control systems — Part 1: General principles for design (ISO 13849-1:2015)
BS EN ISO 13849-2:2012	Safety of machinery — Safety-related parts of control systems — Part 2: Validation (ISO 13849-2:2012)

The person empowered to sign this declaration on behalf of the manufacturer, or the UK or GB authorized representative.

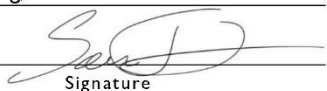
<p>_____ CEO Position</p>	<p>_____ Søren Elisiussen Name</p>
<p>_____ Liftup A/S, Hagensvej 21, DK-9530 Støvring, Denmark Place</p>	
<p>_____ 17 October 2024 Date</p>	<p>_____  Signature</p>



### 3. Factory Acceptance Test (FAT)



**FACTORY ACCEPTANCE TEST**

*Certificate*

is hereby issued to FlexStep V2 with serial no.

*(insert serial number / copy of CE certification mark here)*

**The validity of the CE certificate is subject to correctly performed installation, cf. the manufacturer's instructions.**

**To certify that all safety tests, performance tests and other tests specified by our certified ISO 9001:2015 Quality Management System have been successfully passed and documented.**

\_\_\_\_\_

Issue date

\_\_\_\_\_

Test responsible

---

Liftup A/S | Hagensvej 21 | 9530 Støvring | Denmark  
T: +45 96 86 30 20 | M: mail@liftup.dk  
www.liftup.dk | CVR: DK-1015 3964

---



## 4. Terms of use

As a lift, the equipment is solely for the use of wheelchair users or persons with impaired mobility.



It is important to read the entire user manual before using the lift



**IMPORTANT!**

The lift must NOT be used to transport goods, and pallets containing goods or any other form of heavy load must not be put onto it.



**IMPORTANT!**

There must be no persons on the FlexStep when it is transforming into and from a staircase.



**IMPORTANT!**

The owner of the lift is obliged to maintain it in accordance with the maintenance instructions in section 12.



Do not dispose of batteries, electrical and electronic equipment together with unsorted household waste. When disposing of batteries, local provisions and regulations must be complied with.



**Max 400 kg**  
**Max 880 lbs**

The maximum load is 400 kg, **evenly distributed on the platform** (max. 2 persons).

The owner is obliged to ensure that statutory inspections, checks and service inspections are performed at the correct intervals see section 15, and that the necessary safety equipment is available.





## 5. Technical specifications

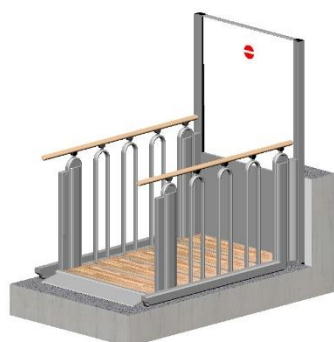

Lower level\*



Staircase\*



Upper level\*

\* The FlexStep lift is shown here with “Raise-to-fold” ramp (ramp with extra length), automatic onboard barrier and vertical barrier.



All scale drawings for the FlexStep lift models can be configured on Liftup’s product configurator: [www.liftup.dk/lpc](http://www.liftup.dk/lpc)

### Specifications:

#### Power supply:

Indoors: 100-240V / 50 Hz (1,1A) Max: 90w, Standby < 6w

Outdoors: 90–305V-AC / 47 - 63 Hz / 1,67 A / 60 W

#### Lifting capacity:

400 kg

#### Lifting height:

240-1295 mm

#### Platform size:

Internal dimensions: W 700/800/900/1000 mm - L 900 mm - 1800 mm

External dimensions: W 930-1230 mm - L 1095-2010 mm

#### Dead weight:

125-205 kg

#### Noise level:

< 70 dB <sup>1) 2)</sup>

<sup>1)</sup> The noise level is an average and, for a short period, noise could occur at > 70 dB

<sup>2)</sup> When “Raise-To-Fold” (RTF) has been activated in connection with ramp selection (optional equipment), the noise level is specified as: < 80 dB

#### Water and dust:

> 50 V: IP67 (Power Supply) / < 50 V: IP23 / < 10 V: IPxx

#### Lifting speed / temperature

°C                      mm/sec.

+40 °C to +5 °C              < 60 mm

+5 °C to -10 °C              20 mm

-10 °C to -20 °C              10 mm

-20 °C to -25 °C              10 mm

Max. 200 kg



Approval:	The Machinery Directive 2006/42/EC
Operating cycle:	2 min. /5 min.
Battery capacity:	30 cycles 25 °C. Full charge = 5 hours
Flat battery:	10 min. charge = 1 trip

**All radio components comply with the following regulations and standards:**

EU	2014/53/EU, Directive for radio equipment and devices (RED)
FCC (USA)	CFR 47 Part 15
DS/EN 62479:2010	Assessment of the compliance of low power electronic and electrical equipment with the basic restrictions related to human exposure to electromagnetic fields (10 MHz-300 GHz)
DS/EN 300 440, v2.1.1	Short Range Devices (SRD);. Radio equipment to be used in the 1 GHz to 40 GHz frequency range (Electromagnetic compatibility and Radio spectrum Matters Draft)
DS/EN 301489-1, v2.2.0	ElectroMagnetic Compatibility (EMC) standard for radio equipment and services; draft (Electromagnetic compatibility and Radio spectrum Matters Draft)
DS/EN301489-17, v3.2.0	ElectroMagnetic Compatibility (EMC) and radio spectrum matters (Electromagnetic compatibility and Radio spectrum Matters)
AS/NZS 4268	Radio Equipment and Systems –Short Range devices
AS/NZS 2772.2	Radio Frequency Fields (mean power < 1 MW)

**Internal receiver in FlexStep (MODULE1)**

2.4 GHz short range devices:	
FCC ID: 2AK8H-MODULE1	
Receiver class	3
Dimensions (L x W x H):	72 x 33 x 10 mm
Weight:	10 g
Frequencies:	2.410 GHz 2.435 GHz and 2.460 GHz
Duty cycle:	< 1% (only TX for pairing of remote control)
Power supply:	< 0.6 MW controlled environment
Power Supply:	5.6 Volt 30 mA
Water and dust:	IP XX (must be installed internally in Liftup products)
Ambient temperature:	+5 °C to +40 °C/ 41 °F to 104 °F
Storage temperature:	-25 °C to +70 °C/13 °F to 158 °F
Expected service life:	> 5 years

**Hand-held wireless remote control (REMOTE1)**

2.4 GHz short range devices:	
FCC ID: 2AK8H-REMOTE1	
Receiver class	3
Dimensions (L x W x H):	96 x 47 x 24 mm
Weight:	48 g



Frequencies:	2.410 GHz 2.435 GHz and 2.460 GHz
Duty cycle:	< 1%
Power supply:	< 0.6 MW controlled environment, 'dead man's switch'
Battery:	3 Volt CR2032
Water and dust:	IP 42
Ambient temperature:	+5 °C to +40 °C
Storage temperature:	-25 °C to +70 °C
Expected service life:	> 5 years

### **Wall-mounted wireless call station (REMOTE2)**

2.4 GHZ short range devices:

FCC ID: 2AK8H-REMOTE2

Receiver class	3
Dimensions (L x W x H):	170 x 72 x 42 mm
Weight:	180-215 g
Frequencies:	2.410 GHz 2.435 GHz and 2.460 GHz
Duty cycle:	< 1%
Power supply:	< 0.6 MW controlled environment, 'dead man's switch'
Battery:	3 Volt CR2032
Water and dust:	IP 54
Ambient temperature:	+5 °C to +40 °C
Storage temperature:	-25 °C to +70 °C
Expected service life:	> 5 years

*Right reserved to make technical modifications.*

### **Patented product**



The following patents apply to the product:

- EP1254858,
- EP1600416



## 6. Safety instructions

### 6.1 Installation, handling and repair

Do not attempt to install or repair your FlexStep lift yourself. This **MUST** be done by an authorised service technician. Do **NOT** remove protective plates or safety plates, as this could lead to your lift causing personal injury.

The lift will normally be delivered by a dealer, who will also be responsible for the installation. Do not attempt to move the lift manually as this could lead to personal injury. The product must be moved and handled using lifting equipment that is suitable for the purpose (pallet lifters, roller plates etc.).

The lift must not be subjected to strong impacts/bumps, as this could affect its functionality.

### 6.2 Unintended movements of the lift

If, while using the lift, actions or movements not described in this manual occur, the lift must be brought to a stop and technical assistance called for.

If the lift does not move on a true horizontal plane as a platform, it must be calibrated by moving the platform down to the lower level. If the problem continues, summon technical assistance.

### 6.3 Operating conditions

The free space under the lift must be kept free of all items/objects that could prevent it moving in a downward direction. Otherwise, the lift cannot be moved to the lowest level and cannot therefore be used as a wheelchair lift.

If an item/object prevents the lift from moving in a downward direction, the anti-crushing safety feature will be activated (see section 6.7).

### 6.4 Avoid personal injury

The FlexStep lift must **NOT** be converted from a staircase to a platform or the other way round when persons or objects are on the staircase.

Keep in mind that the auto return function may be active and consequently transform the lift/platform to a staircase after 60 seconds of inactivity. The lift emits a clear acoustic signal before the auto return function is initiated. The function is easily interrupted by activating a control button, the emergency stop or by activating an IR sensor.

In order to avoid personal injury it is **NOT** permitted to use the lift when anyone is in danger of being injured as a result of crushing, cutting, falling or tripping etc.

It is important for the user/operator to ensure that the lift can move without putting anyone or anything in danger.

Be extra careful when small children, elderly people or disabled people are on or in the vicinity of the staircase/platform, as these groups cannot always be expected to be able to foresee the potential consequences of the movements of the staircase/platform.



## 6.5 Overloading the lift

In order to avoid damage or injury in connection with overloading (max. 400 kg, evenly distributed), the FlexStep lift is equipped with overload protection that stops the lift in the event of overloading and activates an acoustic alarm (see section 10.8) In the event of overloading, move the lift downward to exit.

## 6.6 Personal safety

The FlexStep lift is equipped with various safety devices that ensure that the user or other persons do not come to harm when using the lift.



### **WARNING!**

Although the lift is equipped with various safety devices, it must not be used if there are persons or animals in the vicinity, so as to avoid any risk of crushing.

**Never allow children to play with the lift.**

## 6.7 Anti-crushing safety feature

Beneath the entire lift there are a number of pressure plates (the anti-crushing safety feature) fitted and these are activated in the event of the likelihood of anything becoming crushed underneath. When the anti-crushing safety feature is activated, the lift stops and moves approx. 2 cm upward, while sounding an acoustic alarm (see section 10.8).



If the anti-crushing safety feature is activated, the operating button must be released. Remove any items/objects under the lift and then it can again be moved to the “lift down” or “staircase” position. (Move the lift up a little if necessary in order to remove whatever is under the lift).



### **IMPORTANT!**

Be aware that, in the case of outdoor installations, leaves, branches and snow could affect the anti-crush safety feature and, for this reason, regular checks should be carried out to ensure that the lift cannot be blocked on its way down.



### 6.7.1 Infrared anti-crush safety device

Infrared sensors are mounted between the steps to avoid crushing between the steps and any risk of crushing under the ramp. If the IR sensors are tripped when the FlexStep transforms from staircase to platform or vice versa, movement will cease and an acoustic alarm will be sounded (see section 10.8).

**NOTE!**



FlexStep models with upper double step allow up to 610 mm between the IR sensors. Liftup therefore recommends to have the function “auto return” deactivated on these models. This is also the default factory setting on these models.

Standard models without upper double step allow max. 305 mm between the sensors, and on these models the auto return function is activated. The auto return function can be deactivated or activated by an authorized FlexStep service technician.

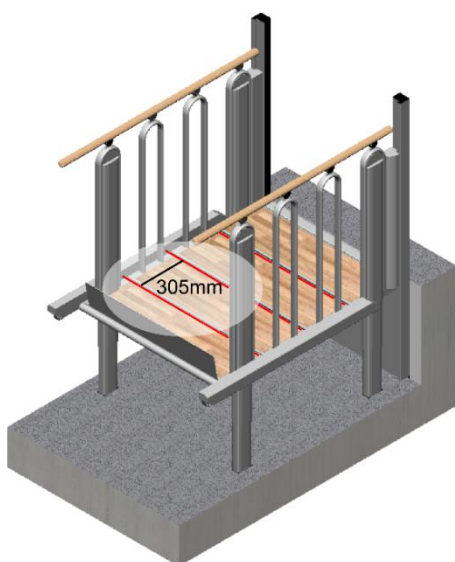

FlexStep without upper double step with 305 mm between the sensors (IR sensors shown with red marking)

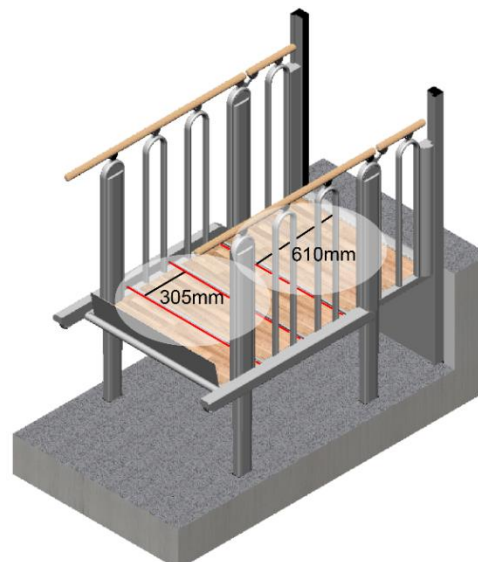

FlexStep with upper double step with 610 mm between the upper landing and the first sensor.



## 6.8 Safety barriers

### 6.8.1 Ramp as safety barrier

The ramp on the platform will tilt up and lock before the lift begins to move. The ramp will now act as a safety barrier. When the lift moves down to the lower level, the ramp will automatically tilt down (keep pressing the button) and act as a drive-on/drive-off ramp.

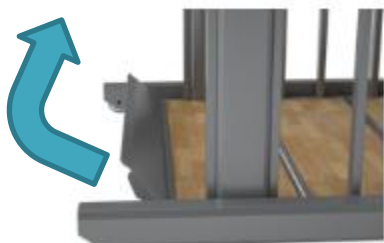

*Ramp as safety barrier*

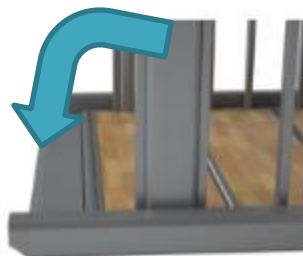

*Ramp as drive-on/drive-off ramp*

### 6.8.2 Automatic onboard barrier (optional equipment)

The automatic onboard barrier is a safety device that safeguards the user against roll-off and entering and accidentally exiting when the user is on the platform. In combination with the active ramp, the two mechanically driven self-locking bars greatly increase the user's sense of security when the user is on the lifting platform.

When the lift is resting at the lower level, the bars hang down along the side of the lift and allow access. When the lift moves away from the lower level and before the lift is more than 50 mm above the lower level, the bars will tilt up and lock. The bars will now act as a safety barrier. When the lift moves back to the lower level or is in stair mode, the bars will automatically tilt down along the side and allow access.

Liftup recommends that the automatic onboard barrier option be chosen for 4, 5 and 6-step lifts.



#### **IMPORTANT!**



The automatic onboard barrier has an integral switch that registers whether the bars are in the correct horizontal locked position. If the bars are NOT in a horizontal locked position before the lift is more than 50 mm above the lower level, the lift will stop its movement until the bars are released and free to tilt up into the locked position.





**WARNING!**

Be aware of the risk of crushing between the handrail and automatic onboard barrier when the lift is transformed from a platform to a staircase.

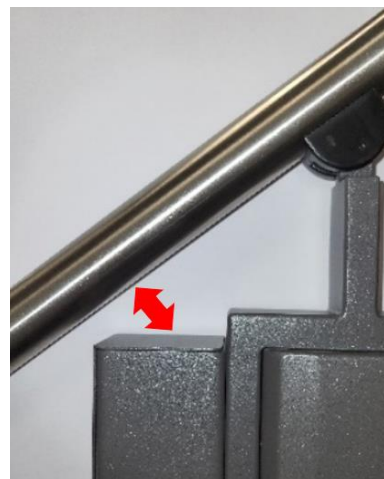

**WARNING!**

Be aware of the risk of crushing between the carrier plate and push plate when the lift is approx. <100 mm from the lower level.

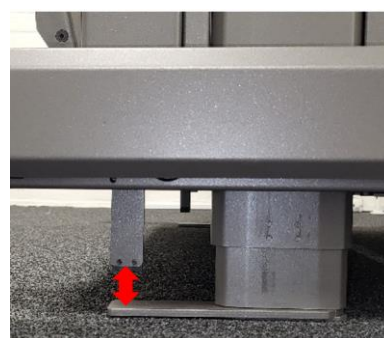

Do NOT sit on the bars



Do NOT lean against the bars

**6.8.3 Vertical barrier (optional equipment)**

If the lift is supplied with a vertical barrier at the upper level, this will be closed before the lift starts to move. The barrier will always be closed when the lift is away from the upper level.

*The barrier is closed, when the lift is away from the upper level*





### 6.8.4 Automatic door (optional equipment)

If the lift is supplied with an automatic door, this will close and the door motor will lock before the lift begins to move. The door will always be closed and locked when the lift is away from the upper level.



#### **IMPORTANT!**

Strong wind may disturb the functionality of the door.

### 6.9 Lifts installed with free access (only certain countries)

If the lift is accessible to the public, it must, as a general rule, be equipped with a key switch so the lift can be locked when it is not under supervision.

In order to prevent persons becoming inadvertently trapped in the lift, it must be possible to lock it so that there is no access to the lift (in the normal manner). The key switch must prevent the lift being able to be moved and ensure that doors can be locked or unlocked where required.

If the lift is not under supervision or locked but the owner (or their representative) is in the vicinity/building, it must be equipped with an alarm signal in order to summon assistance.

If the lift is equipped with an audible alarm this must be connected to an external alarm device (e.g., light, sound etc.) that is able to draw attention to the fact that there is a need for assistance at the lift. If the lift is installed in a manner in which the alarm signal is insufficient (e.g., freely accessible without supervision), two-way communication must be installed.

If the lift is installed with two-way communication equipment, this equipment must be connected to a telephone number that is monitored at all times (when the lift is available).

### 6.10 Breakdown/malfunction

#### 6.10.1 Opening of vertical barrier in emergency

In the event of an emergency/breakdown: Slowly press down the barrier.

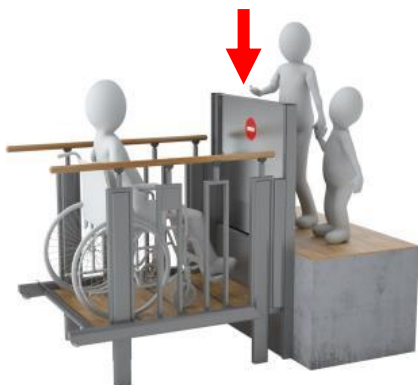

#### **WARNING!**

If you push too quickly, the barrier motor may be ruined.



### 6.10.2 Unlocking the door in an emergency

In the event of an emergency/breakdown: Release the spring bolt.

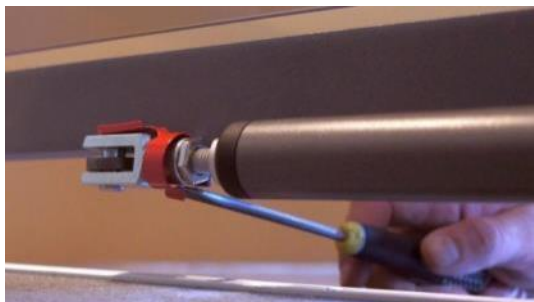

1. Pull the spring out of the spindle shaft using a suitable tool, screwdriver, ruler, bottle opener etc.



2. You can access the lowest part from the outside.



3. The spring is released.



4. Pull out the bolt once the spring has been released.



**NOTICE:**

The bolt may be difficult to pull out due to pressure from the door actuator.



5. The door is now free to be opened.

Once the fault has been rectified, the door can be reconnected in line with these instructions but applied in the reverse order.



### 6.10.3 Unlocking the automatic onboard barrier in an emergency

Push up the pressure plates beneath the lift so that the bars drop down. If necessary, secure the bars with tape, string or suchlike so that they do not tilt up again while exiting. Take one bar at a time.

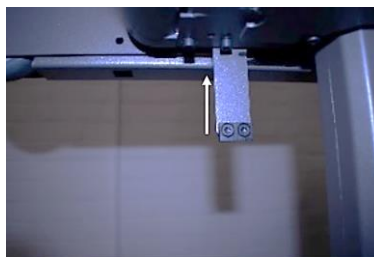

#### **WARNING:**

Risk of personal injury. If you release bars/pressure plate or do not succeed in tying them sufficiently securely, the bars will snap into place.

### 6.10.4 Emergency lighting/power failure



In the event of power failure or if the power supply to the lift's controls is interrupted for some reason, the system will automatically shift to back-up mode. This means that the system will continue to operate because the lift will then be supplied by a back-up battery. The operating panel will continue to be lit up. An acoustic alarm alerts the user that the lift is not in a 'normal operating situation'.

### 6.10.5 Electrical or mechanical faults/defects

In the event of (certain) mechanical or electrical faults, the lift will automatically enter into a special "safety mode", that only allows it to moved downward at low speed. It is not possible to move upward, see section 11.2.

### 6.10.6 Emergency evacuation in the event of a malfunction

In the event of other (serious) faults where the lift cannot be lowered in "safety mode" (slow, downward operation), only a service technician will be able to make the lift move by means of a special "service mode" to which the user does not have access. It is not possible to lower the lift manually, but the user can be helped off of the lift manually in such an event by virtue of the low lifting height (max. 1295 mm). If a user needs to be lifted off of the lift (e.g., a wheelchair user) suitable lifting equipment/aids should be used.

The vertical barrier or door at the upper level can be opened to allow access to the lifting platform (see description below). Lift installations that are not under constant supervision can be equipped with an alarm.



## 7. Function description



The lift is a so-called “dead man’s switch” lift, i.e., the push buttons must be pushed in throughout the entire operation.

The lift is easy to operate: The user summons the lift using one of the buttons on the wall, on the call station column or the accompanying remote control (optional equipment). When the user is on the platform, it is operated from the panel on the side, from where transport to the upper or lower level is selected.

## 8. Assembly

The lift is installed by an authorised service technician. Do not attempt to move or uninstall the FlexStep or to repair it. This **MUST** be done by an authorised service technician.

In the event of incorrect assembly, there may be a safety risk for users. Liftup is exempt from any liability if assembly and installation are not performed by an authorised service technician.

Contact your dealer for further information regarding installation of the lift:

<https://www.liftup.dk/en/contact/>

## 9. Start-up

The FlexStep must always be connected to a 100-240 V socket and be switched on. Normally, the FlexStep is always in “standby mode”, i.e., it is ready for use as soon as one of the operation keys is pressed.

If the emergency stop button is pressed, or the lift has been disconnected through the key switch, this must be deactivated before the lift can be used (find out more in section 10).

## 10. Instructions for the use

The FlexStep is a unique 2-in-1 application, designed to act as both a staircase and a wheelchair lift. To begin with, the FlexStep is an ordinary staircase but, by pressing on the operating buttons, it folds up or down into a platform and becomes a wheelchair lift.





## 10.1 Everyday use

The FlexStep can be activated and operated by means of the operating panel on the platform (fig. 12), a remote control (optional equipment) (fig. 9) or operating panels on the upper and lower levels respectively: Standard call stations (figs. 1-4), call station columns (figs. 5-8) or key-operated call stations (fig. 10) In addition, the lift can be turned on and off by means of a key switch (optional equipment) (fig. 11).



Fig. 1:  
Standard call station with  
cable, 2-way



Fig. 2:  
Standard call station with  
cable, 3-way



Fig. 3:  
Standard call station,  
wireless, 2-way



Fig. 4:  
Standard call station,  
wireless, 3-way

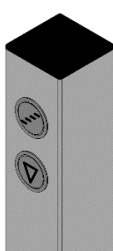

Fig. 5:  
Call station column with  
cable, 2-way

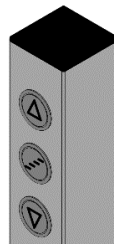

Fig. 6:  
Call station column with  
cable, 3-way

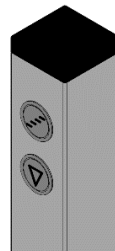

Fig. 7:  
Call station column,  
wireless, 2-way

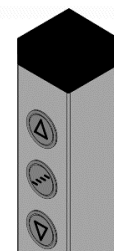

Fig. 8:  
Call station column,  
wireless, 3-way





Fig. 9:  
Remote control  
(optional equipment)



Fig. 10:  
Key-operated call station

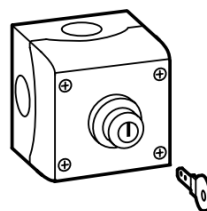

Fig. 11:  
Key switch ON/OFF



Fig. 12  
Operating panel on the  
lift  
(optional equipment)  
with/without alarm

## 10.2 Operation of the FlexStep from the UPPER level



The lift is activated from the UPPER level by pressing and holding in the arrow button (▲) on the operating panel. The barrier/door on the upper level closes.

The staircase is transformed into a platform and first moves to the LOWER level where the roll-off protection/ramp (fig. 1) and the automatic onboard barrier (fig. 2) are raised and locked.

The platform then moves to the UPPER level and the barrier/door at the upper level is opened so that access is given to the platform. Drive onto the platform carefully and lock/brake the wheelchair (fig. 3).

Press and hold in the arrow button (▼). The barrier/door closes and the platform moves down to the LOWER level. When the platform reaches the lower level, the roll-off protection is lowered and the ramp acts as a drive-on/drive off ramp (fig. 4). Drive away from the platform carefully (fig. 4).

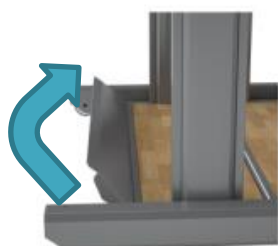

Fig. 1:  
The ramp is raised and  
locked



Fig. 2:  
The automatic  
onboard barrier  
(optional equipment)  
is raised and locked



Fig. 3:  
Drive onto  
the platform



Fig. 4:  
Drive off  
the platform



### 10.3 Operation of the FlexStep from the LOWER level



The lift is activated from the LOWER level by pressing and holding in the arrow button (▼) on the operating panel. Barrier/door on the upper level closes.

The staircase is transformed into a platform and moves to the LOWER level. When the platform reaches the lower level, the roll-off protection/automatic onboard barrier are lowered (figs. 5 and 6) and the ramp acts as a drive-on/drive-off ramp (fig. 5). Drive onto the platform carefully and lock/brake the wheelchair (fig. 7).



Press and hold in the arrow button (▲). Drive-off ramp and automatic onboard barrier are raised, and the platform then moves to the UPPER level and the barrier/door at the upper level is opened so that it is possible to exit at the UPPER platform. Drive away from the platform carefully (fig. 8).

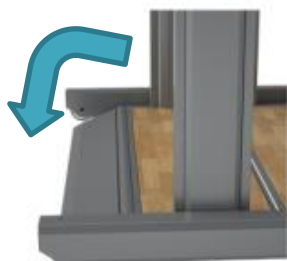

*Fig. 5:  
The ramp lowers*

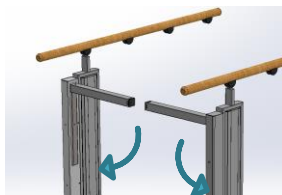

*Fig. 6:  
The automatic  
onboard barrier  
(optional equipment)  
lowers*



*Fig. 7:  
Drive onto the  
platform*



*Fig. 8:  
Drive off the platform*

### 10.4 Operation of FlexStep on the platform



The FlexStep is operated as a wheelchair lift by means of the operating panel mounted on the staircase rail or using the remote control (optional equipment). The panel on the platform only works when the FlexStep is in platform mode. The operating panels on the wall/remote control (optional equipment) can also help to control the up and down movement of the platform.

- To move the platform up, press the arrow button (▲) and keep pressing it until the lift stops and the door or barrier, as applicable, opens.
- To move the platform down, press the arrow key (▼) and keep pressing on it until the lift stops, the automatic onboard barrier lowers and the exit ramp moves down and acts as a drive-on/drive off ramp.



## 10.5 Return to staircase and auto return



By activating the button with the staircase symbol, the FlexStep can be transformed to its normal function as a staircase.

Be aware that if no operating buttons or IR sensors have been active for approx. 60 seconds (default programming), the FlexStep will automatically return to its normal position as a staircase (auto return). An acoustic alarm will be sounded during this operation (see section 10.8). The function can be disabled if you do not want the lift to automatically revert to a staircase.

For FlexStep models 2+1, 3+1 and 4+1 however the auto return function is always deactivated at the factory in order to prevent a possible risk of dangerous situations, cf. section 6.7.1.

### IMPORTANT!



Liftup recommends that the auto return function is always disabled if there are no safety measures taken at the upper level as well as for FlexStep lifts with upper double step as a dangerous situation may arise, cf. section 6.7.1.

### IMPORTANT!



An authorized service technician/dealer may examine whether the automatic measure is permitted, cf. the legislation in the country in question which must always be observed.

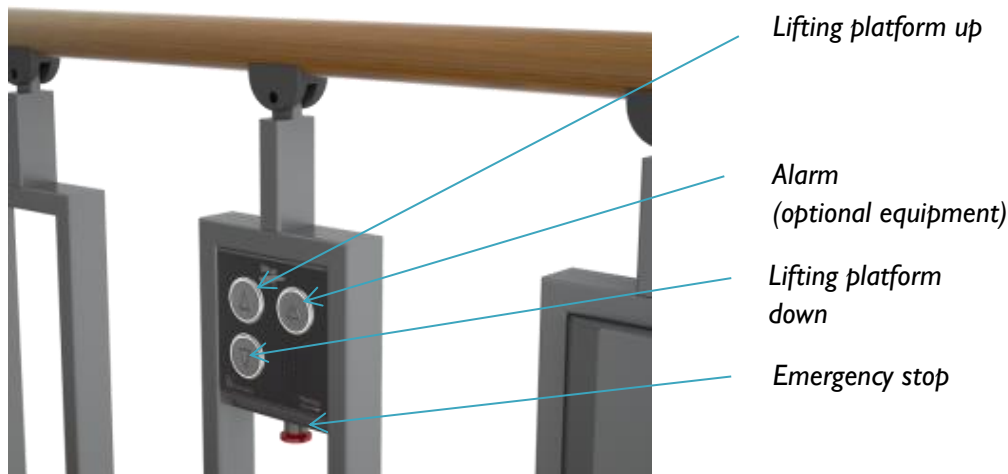

## 10.6 Emergency stop



If the lift makes an unintended movement or if it needs to stop in order to avoid an element of danger, press EMERGENCY STOP. In order to disengage the emergency stop, turn the button clockwise and the system will be ready to use.



To operate an alarm function on the operating panel, see section 10.9.





## 10.7 ON/OFF switch for the battery charger

The lift is equipped with an ON/OFF switch for the battery charger. The switch is used to interrupt the power supply from the charger to the lift. If the switch is set to OFF, the lift runs on the batteries only. If the switch is set to OFF and the emergency stop is activated at the same time, the power supply from the batteries to the lift will also be interrupted. After approx. 10 seconds the lift will be turned off completely.

The ON/OFF switch for the charger is used for example in connection with service and maintenance work.

When the power supply from the charger is reconnected (ON), and the emergency stop is released, the control system restarts (see section **Fejl! Henvisningskilde ikke fundet.**). The switch is normally set to ON so as not to damage the batteries.

### **WARNING!**



The ON/OFF switch can interrupt the power supply from the charger to the lift. It is not the mains. If it is set to OFF over a longer time-span, it may drain and damage the batteries. In the event of a long-standing power outage, the emergency stop should be activated to ensure that the batteries are not completely discharged.

The switch is placed at the right side under the electronics compartment.

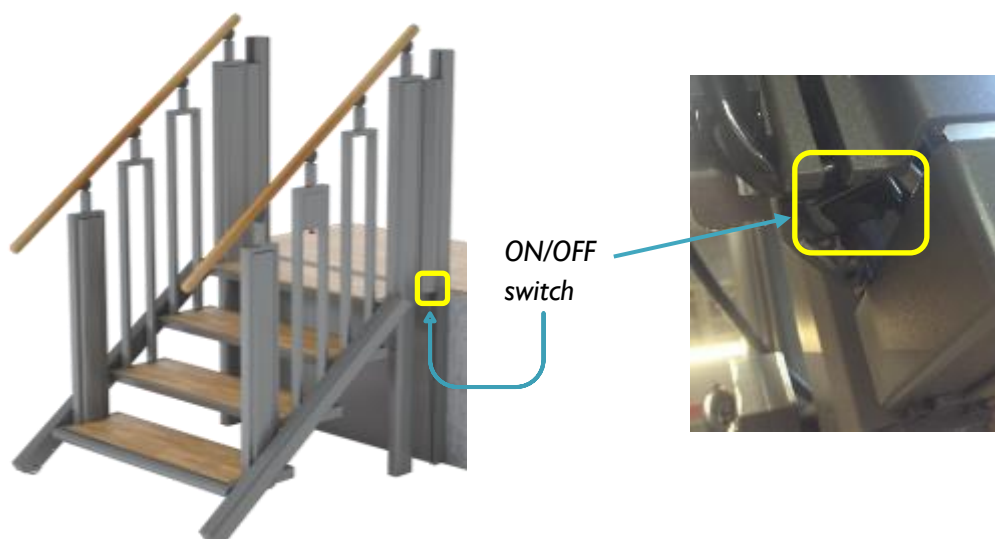

## 10.8 Acoustic alarms

Speak	Activity/warning	
Opening	The safety barrier is opening	■ ■ ■ ■
Closing	The safety barrier is closing	■ ■ ■ ■
Alarm: Overload	The platform is overloaded	■ ■ ■ ■ ■ ■ ■ ■ ■ ■
Alarm: Battery fault – lift cannot be used	There is a battery fault. Inadequate power supply (see section 5 Technical Specifications)	■ ■ ■ ■ ■ ■ ■ ■ ■ ■
Alarm: Item/object under the lift	Remove whatever is under the lift and preventing downward travel	■ ■ ■ ■ ■ ■ ■ ■ ■ ■
Alarm: IR sensors tripped	Remove whatever is under the lift and preventing downward travel	■ ■ ■ ■ ■ ■ ■ ■ ■ ■
Alarm: Item/object under the lift	The transformation from platform into staircase is not possible as someone/something is on the platform.	■ ■ ■ ■ ■ ■ ■ ■ ■ ■
Ding Ding Ding	Arriving at upper/lower level	
Ding Ding Ding	The lift has transformed into a staircase	
Warning: Running automatically	Warning that the lift is about to transform into a staircase.	
BEEP-BEEP-BEEP...	The lift is in the process of transforming into a staircase.	■ ■ ■ ■ ■ ■ ...
Emergency stop pressed	The red emergency stop button has been pressed. It needs to be released in order for the lift to be able to operate.	■ ■ ■ ■ ■ ■
The lift is locked	The lift is locked with the key switch.	■ ■ ■ ■ ■ ■
Alarm: Battery warning	Low battery level.	■ ■ ■ ■ ■ ■
Alarm: Power supply interrupted – Connect or press emergency stop	Connect power supply or activate emergency stop in order to switch off the staircase.	■ ■ ■ ■ ■ ■

■ ■ High-pitched tone followed by a lower pitched tone

■ ■ Low-pitch tone followed by a higher pitched tone

||| 3 identical tones



## 10.9 Alarm and emergency call



The lift can be equipped with an alarm button that can summon assistance. In order to activate the alarm, press on the alarm button and hold it in for approx. 5 seconds.

The alarm button can be connected in several ways:

1. The alarm button is connected to an alarm sensor in the lift that emits a high-pitch beeping tone that alerts others that there is a need for assistance at the lift.
2. The alarm button is connected to a call system that allows the user to contact external assistance, either using an analogue connection or by using a SIM card.



*Preventive relay output*



*Analogue connection  
(SafeLine)*



*SIM card (SafeLine)  
EMEA countries only*

### SafeLine QR

More detailed information regarding the operation and functions of the SafeLine call system can be found here:

SafeLine MX3: <https://www.safeline-group.com/en/qg/mx3>



1. Alarm button
2. Microphone
3. Status LED for communication module



## 11. Operation

Under normal operating conditions the lift shall always be connected to a 100-240V (indoor)/ 90–305V (outdoor) socket. It is very important that the power is not disconnected or switched off, as a lengthy interruption of the power supply (10-20 hours) could result in flat batteries and thereby an operational stoppage. The lift can then not be used until the batteries are recharged. If the power supply is interrupted, an acoustic alarm will sound (see section 10.8).

### 11.1 Battery back-up

In the event of a power failure, or if the power to the controls is interrupted in some other manner, the controls will automatically switch to back-up mode. This means that the system will still operate absolutely normally, since the lift will be supplied by the battery. To warn of power failure, an acoustic alarm will sound (see section 10.8). As soon as the supply is reconnected, the alarm will stop. The system will now operate again in normal mode. If it is not possible to connect the power supply immediately and you wish to stop the alarm, press the emergency stop. (Be aware that the system will require calibration, see below).



#### **IMPORTANT!**

If the power supply has been disconnected and the emergency stop has been activated at the same time, the system will automatically switch to “safety mode” and the system must then be calibrated (see below).

### 11.2 Calibration after emergency stop/power failure

If the emergency stop has been activated and the power supply interrupted, or if the system registers any other form of irregularity, the lift will need to be calibrated. The lift automatically enters into a special “safety mode” that only allows it to move down at low speed until the lift reaches the floor.



#### **IMPORTANT!**

If the lift does not operate as expected or stops again after a few centimetres, technical problems may have arisen and require a repair by technical staff. Contact your dealer for further assistance.



## 12. Maintenance

Clean by wiping off with a cloth that has been wrung out in water containing a mild detergent.



### **IMPORTANT!**

Do NOT use a high-pressure cleaner or wash the lift down with water straight from a hose. Aggressive detergents and suchlike must not be used on the lift. Also avoid salt or sand coming into contact with the lift in connection with winter maintenance.

Any oiled wooden surfaces must undergo regular maintenance (approx. every 3 months) using wood oil in order to ensure the wood's life expectancy is achieved. Varnished wooden surfaces must have fresh varnish applied as necessary.

The accompanying remote control (optional equipment) must be stored in a dry place and not be subjected to strong impacts by, for example, throwing it about. It must only be cleaned using a cloth that has been wrung out.

Perform regular checks under the lift for any leaves, branches or other items/objects and remove these in order to ensure it travels freely.

### **12.1 Replacement of battery in call stations/remote control**

A CR2032 battery is installed in the wireless call stations, call station column (optional equipment) and remote control.



The battery must be replaced every two years to ensure stable operation.



BE SURE not to swallow the button battery and avoid putting the battery in your mouth due to the risk of swallowing it.



Keep the batteries out of the reach of small children. If a child swallows a battery, contact a doctor immediately.



Do not dispose of the battery together with unsorted household waste. When disposing of batteries, local provisions and regulations must be complied with.



## How to replace the battery

### Hand-held remote control:

1. Loosen the screw (Torx TX 6) on the rear of the remote control
2. Remove the rear panel
3. Replace the battery
4. Replace the rear panel and test the remote control



### Call station:

In order to gain access to the battery, loosen the 2 Torx screws and pull down the top cover to separate it from the body.

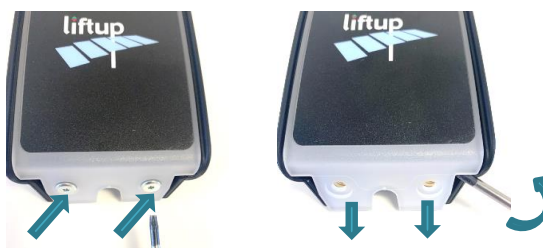

### Call station column

To gain access to the battery, loosen the 4 screws and pull up the top cover carefully.

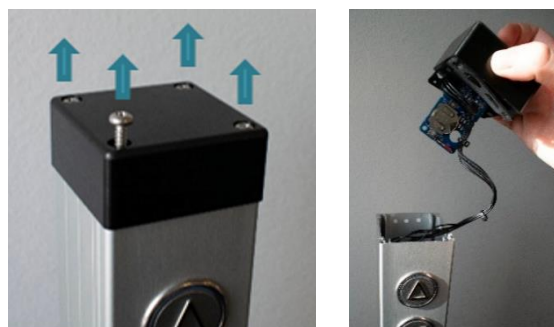

### IMPORTANT!

Be careful not to disconnect the wires from each other. Pull the printed circuit out of the top cover carefully.

1. Replace the battery
2. Put the unit together in the reverse order and test the buttons.



If the remote control or receiver has been without power for a long period of time, it may be necessary to calibrate the system (pair the two units), see section 13.



## 13. Pairing transmitter and receiver

### 13.1 Wireless call station/call station column 2.4 GHz

The transmitter and receiver must always be paired in order to work. This is normally done at the factory or by an authorised service technician. The receiver will not respond to a transmitter it is not paired with. A receiver can be paired with up to 20 transmitters. A transmitter can be connected to several receivers if necessary.

#### How to pair the transmitter and receiver:

1. To gain access to S4 on the receiver, loosen the top screw and pull up the receiver "MODULE1" from the top of the wall profile.
2. Press briefly on S4 on the receiver and the control light (LED) will start to flash slowly. The receiver will now be in installation mode for 2 minutes.
3. Gaining access to the transmitter.



#### Call station

In order to gain access to the printed circuit board, loosen the 2 Torx screws and pull down the top cover to separate it from the body.

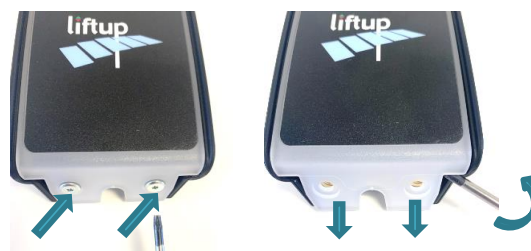

#### Call station column

To gain access to the printed circuit board containing the transmitter, loosen the 4 screws and pull up the top cover carefully. Pull the printed circuit out of the top cover carefully.

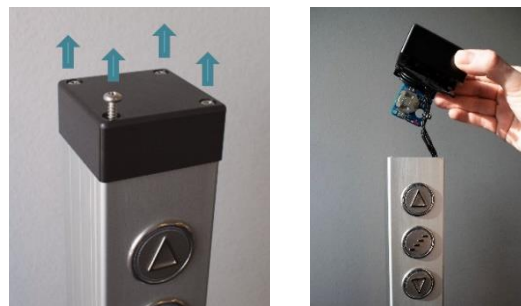

#### IMPORTANT!

Be careful not to disconnect the wires from each other. Pull the printed circuit out of the top cover carefully.



- The printed circuit containing the transmitter is now visible and should be briefly pressed at S4 in order to pair it with the receiver (must be done within 2 minutes).

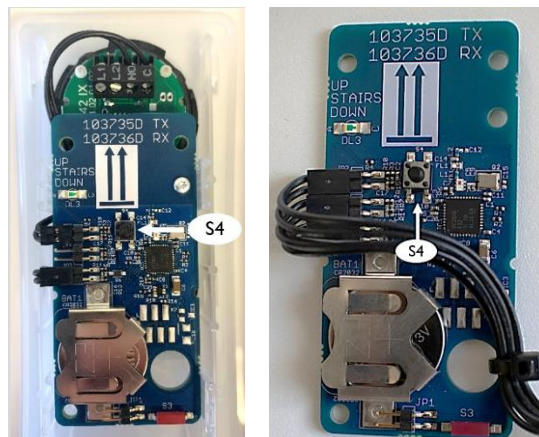

- Test the system to ensure that the pairing has been done correctly; if not, repeat points 1-4.
- If several remote controls are to be paired with the receiver, repeat from step 2 above.
- Replace the top cover

To reset a call station/call station pillar so that it is no longer paired with the lift, the following points should be followed:

**How to reset the transmitter:**

- Press S4 (2) on the transmitter for more than 10 seconds.
- Once the control light LED (1) starts to flash rapidly, the transmitter has been reset.



**How to reset the receiver:**

- Press S4 (2) on the receiver for more than 10 seconds.
- Once the control light LED starts to flash rapidly, the receiver has been reset.





## 13.2 Remote control 2.4 GHz

The transmitter and receiver must always be paired in order to work. This is normally done at the factory or by an authorised service technician. The receiver will not respond to a transmitter without it having been paired with the receiver. A receiver can be paired with up to 20 transmitters. A transmitter can be paired with several receivers if necessary.

### How to pair a transmitter and receiver:

1. To gain access to S4 on the 2.4 GHz receiver, loosen the top screw and pull up MODULE1 from the top of the wall profile.
2. Press briefly on S4 on the receiver and the control light will start to flash slowly. The receiver will now be in installation mode for 2 minutes.
3. Press the 'up arrow' (↑) and 'down arrow' (↓) on the remote control at the same time and hold them down for 5 seconds until the control light on the remote control starts to flash slowly. The remote control will now be in installation mode for 2 minutes. It should be flashing yellow. If it is flashing red, it is an 868 MHz model and is not suitable for the receiver.



### Alternatively:

Press on Connect (S4), if the remote control is open.

4. Once the control light on the remote control stops flashing, it has been paired with the lift.
5. Test the system to ensure that the pairing has been performed correctly; if not, repeat 1-4 above.
6. Repeat from step 2 above if several remote controls are to be paired.

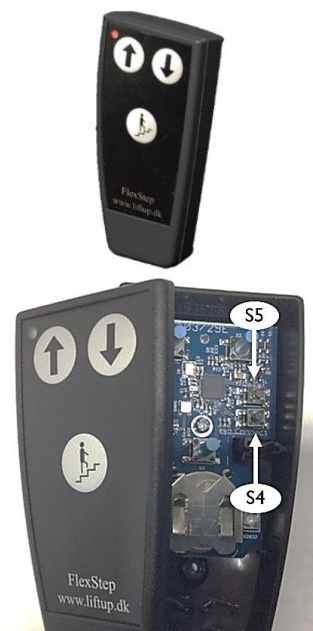

To reset a remote control so that it is no longer paired, the following points should be followed:

**How to reset the transmitter**

1. Press the Up (↑) and DOWN (↓) buttons at the same time for 5 seconds until the control LED on the remote control starts to flash slowly.
2. The remote control is now in installation mode for 2 minutes. The following sequence must be performed within the 2-minute period:

Press: UP(↑), UP(↑), DOWN(↓), DOWN(↓), UP(↑), DOWN(↓), UP(↑), DOWN(↓)

If the sequence is performed correctly, the control light (LED) flashes rapidly 10 times.

**Alternatively:**

Press Reset (S5), if the remote control is open.



Test the system to ensure that the reset has been done properly and that the remote control is no longer paired. If not, repeat points 1-3 above.

**How to reset the receiver:**

1. Press S4 on the receiver for more than 10 seconds.
2. Once the control light starts to flash rapidly 10 times, the receiver has been reset.

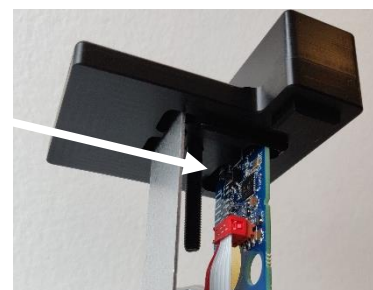

## 14. Installation and handover

The installation and handover check list below, which lists the lift's operating and safety functions, must be gone over with the user/owner of the lift before installation is concluded.



### Installation and handover – FlexStep V2

Version: 7.0

Installation site		Product	
Name/Company		Product	
Address		Serial number	
Postal code/City		Installation date	
Contact person		Installed by	
Telephone		Customer accept	

Checklist:

No.	Description	Checked
1	Perform test with client, including control units, doors/barriers/ramp, full operation, emergency stop.	<input type="checkbox"/>
	Review of the manual with client, including:	
	Instruction of use	
2	• Operating units	<input type="checkbox"/>
3	• Key Switch On/Off	<input type="checkbox"/>
4	• Auto return function (automatic, activation/deactivation, personal safety)	<input type="checkbox"/>
5	• Emergency stop	<input type="checkbox"/>
6	• ON/OFF switch for the charger and the effect on the battery	<input type="checkbox"/>
7	• Alarm and emergency call	<input type="checkbox"/>
8	• Parring operating units	<input type="checkbox"/>
	Safety instructions	
9	• Audible alarms	<input type="checkbox"/>
10	• Handling	<input type="checkbox"/>
11	• Warnings	<input type="checkbox"/>
12	• Overload	<input type="checkbox"/>
13	• Personal safety, including auto return function	<input type="checkbox"/>
14	• Anti-crushing	<input type="checkbox"/>
15	• Safety barriers	<input type="checkbox"/>
16	• Emergency evacuation	<input type="checkbox"/>
	Maintenance	
17	• Cleaning	<input type="checkbox"/>
18	• Replacement of battery in call stations	<input type="checkbox"/>
19	• Explain outdoor treatment: (no salt, no high-pressure water)	<input type="checkbox"/>
20	Inform the client about the legal requirements for statutory and service inspection.	<input type="checkbox"/>
21	Present the customer for the possible service agreements.	<input type="checkbox"/>
22	Update service log	<input type="checkbox"/>

Comments



Liftup A/S | Høgensvej 21 | DK-9530 Støvring | Danmark | T: +45 9686 3020 | M: support@liftup.dk | CVR: DK-1015 3964



## 15. Inspection, checks and service inspections

In addition to the general maintenance described in section 12, regular service inspections and statutory checks and inspections of the lift must be carried out.



### **IMPORTANT!**

For safety reasons, it is very important that these service inspections and statutory checks are complied with, as a lack of, or incorrectly performed, examinations, checks and inspections could result in personal injury.

### 15.1 Statutory inspection and checks

Statutory inspections and checks of the lift are to be carried out, as it is approved for the transport of people. It is the owner's responsibility and obligation to ensure that this is complied with.



### **IMPORTANT!**

The number of statutory inspections depends on the legislation in the country in question.

### 15.2 Regular service inspections

As a manufacturer, we lay down requirements for regular service inspections of the lift to be carried out, see the interval stated below.



### **IMPORTANT!**

The warranty may become void if the minimum requirement for service inspections is not observed.

#### **The manufacturer's minimum requirements for number of service inspections per year:**

	Indoor	Outdoor
Not freely accessible	1	2
Public	2	4

As a manufacturer, we recommend that the regular service inspection be carried out by an authorised service technician. The dealer from whom you have purchased the product will offer this service but, if you wish to use another service provider, it is the owner of the lift who will be responsible for the service technician chosen having received training on the product in question. See also: <https://www.liftup.dk/en/contact>.



### **IMPORTANT!**

The emergency stop must be activated before servicing the lift. This is to protect against accidental operation. The service technician is responsible for the emergency stop being pressed before commencing the service.

**NB:** It is not sufficient to interrupt the power supply, as the system is equipped with a battery backup.



### 15.3 Service report to be used for service inspections

## Service Report – FlexStep V2

Version: 6.0

Service visit paid for by:	<input type="checkbox"/>	<input type="checkbox"/>	<input type="checkbox"/>
Name/company			
Address			
Postal code			
Phone			
Contact person			
Dir. phone/mobile			
EAN/GLN			

Product	Service level
Product type no.	No agreement      6 times annually
Serial number	
Installation date	Date stipulated for service visit
Latest service, date	Details agreed for the visit

Other comments
Service technician

**Checklist**

<input type="checkbox"/> Operating units (onboard and remote)	<input type="checkbox"/> All IR sensors (Upper and Lower): function and cleaning according to instructions
<input type="checkbox"/> Emergency stop contact	<input type="checkbox"/> Retightening of balusters and wall profiles
<input type="checkbox"/> Lifting columns: Check all 4 actuators (function and capacity)	<input type="checkbox"/> Lock rings on side frame
<input type="checkbox"/> All pressure plates / safety pans are checked (under steps and side frame)	<input type="checkbox"/> Latest version of firmware installed
<input type="checkbox"/> Vertical barrier / door (function)	<input type="checkbox"/> Load sign present and correct
<input type="checkbox"/> Ramp/onboard barrier is checked (function and friction). Retighten ramp suspension.	<input type="checkbox"/> Mandatory Inspections* have been carried out – date not exceeded
<input type="checkbox"/> Check audible alarm	<input type="checkbox"/> Updated service log
<b>Outdoor:</b>	<input type="checkbox"/> User manual available by lift
<input type="checkbox"/> Check gaskets, plugs, switches and actuator cables	

\* If statutory inspections are missing, owner must be so advised, in writing + note made in logbook.

**Spare parts replaced**

Article no.	Quantity	Description	Price/unit	Price
		Service/inspection		
		Service technician, hours		
		Distance travelled (km)		

This service report contains checkpoints required by the manufacturer.  
Please make sure to also follow local ordinances and regulations for inspection and service of platform lifts.

Liftup A/S | Hagensvej 21 | DK-9530 Støvring | Denmark | T: +45 9686 3020 | M: support@liftup.dk | CVR: DK-1013 3964



## 15.4 Service logbook

The form (like the example below) must be completed after each inspection.



### Service logbook

Version: 3.0

Installation site		Product	
Name/Company		Product name	
Adress		Serialnumber	
Postcode / City		Installation date	
Contact person		Installed by	
Telephone no.			

Comments

No.	Date	Lognotes	Signature
1			
2			
3			
4			
5			
6			
7			
8			
9			
10			
12			
13			
14			
15			

lifting people

Liftup A/S | Hagensvej 21 | DK-9530 Støvring | Danmark | T: +45 9686 3020 | M: support@liftup.dk | CVR: DK-1013 3964



## 16. Online service log (only certain countries)

The QR code can be scanned using a smartphone, tablet etc. The QR code is on the front part of the left-side frame:



In section 3, a CE mark has been inserted with this specific lift's serial number and QR code with direct access to the lift's online service log. When the QR code is scanned, direct access is given to the lift's online service log and a new log is set up. The fields are filled in and the service technician/installer/regulating authority signs this off electronically in the log after each visit.

Log no. #1	Log entry date	Created by	Log entry text	Comments	Signature
1	15/01/2019	PB	Installation/opstilling af lift	Liften er installeret. Intet avvigt at bemærke ifm. installationen.	PB
2	16/01/2019	Peter Pedersen	Opstillingskontrol	Liften er opstillingskontrolleret ifm. bekendtgørelse, uden bemærkninger. Lifte må herefter tages i anvendelse	PP
3	13/02/2020	Hans Jensen	Årlig eftersyn	Årlig eftersyn gennemført ifm. serviceaftale med Liftup A/S. Intet avvigt at bemærke.	HJ

Add log entry

1. Her kan du se udstyrsdetaljer såsom: serienummer, produktionsår med mere.  
 2. Klik på linket for at se en video om produktet.  
 3. Dette er selve "log-bogen" for udstyret. Denne skal opdateres af serviceelektrikeren ved hvert service besøg.  
 4. Loggen skal udfyldes med dato, navn, en sigende log entry tekst samt relevante kommentarer. Til slut underskrives loggen elektronisk.



## 17. Spare parts and accessories

### IMPORTANT!



It is important to always use original spare parts. Parts must only be replaced by an authorised service technician. If non-original spare parts are used, the factory guarantee may become void. Furthermore, the safety of the product may be compromised, leading to the risk of personal injury.

For information regarding spare parts and services, please contact our distributors:

<https://www.liftup.dk/en/contact>

Art. No.	Description
103332	Spare part package - FlexStep V2
100338	Micro Switch - Safety system - V4L IP67
100339	Emergency stop button
100413	Spring for ramp lock
103815	Brake for ramp
101139	Timing belt
103482	Control Board for FlexStep V2
103738	Print for connection board FSV2/ELV3 2.4 GHz
102744	Motor for barrier, FS2
102759	POM guide for stairs/wall profile
102766	Brush for wall profile
102768	Spring for safety barrier contact
102769	Print for safety barrier contact
102890	Battery 12V 5Ah LiFePo4 FlexStep V2
103008	IR Safety RX board - FlexStep V2
103009	IR Safety TX board - FlexStep V2
103011	IR Termination board - FlexStep V2
103033	Plastic washer for steps, FS2
103080	Power supply unit 36 V (EU)
104198	Power supply unit 36 V (US)
103090	Circlip for steps, FS2
103091	E-chain for FS2
103092	Mounting bracket for E-chain
100336	Motor for ramp FS2
103108	Complete spindle unit with motor
103289	Push button, FS2, arrow, outdoor
103290	Push button, FS2, bell, outdoor
103333	Programming Cable FS2





## 18. Disassembly

In order to ensure the correct disassembly of the lift in order to install it elsewhere, it is recommended that an authorised service technician be used. Contact your dealer for assistance with disassembly.

Be aware that there could be a risk of the FlexStep accidentally tilting/tipping over when it is disengaged from the building.

## 19. Disposal

The owner is responsible for disposing of the product in accordance with the rules applying at any time. Be particularly aware that batteries are fitted in the control unit and remote control and these need to be disposed of separately.



### **IMPORTANT!**

Do not throw the batteries into the waste bin. When you dispose of batteries, local provisions and regulations must be complied with.

Where necessary, contact your distributor for assistance with disposal.

### **19.1 Material specification for FlexStep**

<b>Material</b>	<b>Included in the following components/parts<sup>1)</sup></b>
Steel (S 235 JR)	Frame, step, frames <sup>2)</sup> , handrails,
Aluminium (Al-Mg G3)	Ramp, cover plates, pressure plates, frames <sup>2)</sup> , step inserts
Brass (Cu Zn 39 Pb 3)	Bushings, gaskets, handrails
Plastic Polyoxymethylene (POM)	Handrail bushings, slide rails, bushings, gaskets
Wood (oak, beech, mahogany, etc.)	Step inserts, handrails
Electronics	Controls/PCB, lift columns
Copper	Cables

<sup>1)</sup> Call stations, call station columns and other external components are not included.

<sup>2)</sup> Depending on the model, frames may be made of steel or aluminium.



## 20. Warranty

The warranty applies in relation to the rules applying to the warranty any time.

Liftup offers a full 2-year warranty on spare parts, provided the product has been registered with Liftup (<http://lpr.liftup.dk/>):

### Product Registration

Register your product today and receive 2-years liability for defect on your product directly from Liftup.

Product ID - Serial no.   [?](#)

Type of registrant

First name

Last name

Organization

Address

City

Region / State

Zip Code

Phone

Email

Language

Copy of receipt  Der er ingen fil valgt

If you want to stay updated regarding the latest news and updates, please fill in the check box.

By registering your information, you agree that Liftup may keep your information in the 2-year period of Liability for defects and contact you upon updated user guides and product safety. When the period of Liability for defects has expired, we will contact you again to ask if we may retain your information. Otherwise they will be deleted. Additionally, this information is used for internal statistics, but is not disclosed to third parties. You can revoke your consent at any time.

For any questions regarding registration or liability for defects please contact [mail@liftup.dk](mailto:mail@liftup.dk).



Find out more about this in our sales and delivery terms, which can be found on our website: <https://www.liftup.dk/en/about-liftup/general-conditions/>



**NB:**

The warranty may become void if the prescribed service inspections are not observed.

If the prescribed inspections, checks and service inspections are not observed, see section 15, this could have serious consequences for the safety of the product. It is the customer's responsibility to ensure that the product complies with the prescribed inspections, and service inspections at all times, see Order No 461 of 23 May 2016, Appendices 2 and 3 and the Danish Working Environment Authority's Order no. 1109, Section 14.







# lifting people

We want to change the way people think about access products: More than a technology you need – it's a technology you want. We design thoughtful, holistic and aesthetic access solutions where every element adds to improve the total user experience. We create unique tailor-made solutions where our products help people and are fully and beautifully integrated in the architectural environment. This means that our access solutions also have an emotionally uplifting and satisfying impact – because they are comfortable, user-friendly and well-designed. This also means that we can transform access enablers from being tools that solves a task for the few – to being smart and pleasurable design elements for everyone to enjoy.

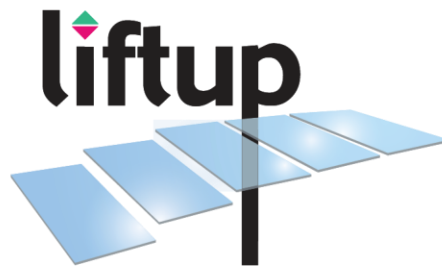

**Distributed by:**

[WWW.LIFTUP.CO.UK](http://WWW.LIFTUP.CO.UK)